



# CORDLESS PORTABLE POWER CLEANER – TOOL ONLY

24-VOLT MAX\* | 350 PSI MAX† | 0.6 GPM MAX‡

## OPERATOR'S MANUAL

A Division of Snow Joe®, LLC

Model 24V-PP350-CT

Form No. SJ-24V-PP350-CT-880E-M

## IMPORTANT! Safety Instructions

### All Operators Must Read These Instructions Before Use

**⚠️ WARNING!** This indicates a hazardous situation, which, if not avoided, could result in death or serious injury.

**⚠️ CAUTION!** This indicates a hazardous situation, which, if not avoided, could result in minor or moderate injury.

**⚠️ DANGER!** This indicates a hazardous situation, which, if not followed, will result in death or serious injury.

### General Safety

**⚠️ WARNING!** This appliance is not intended for use by children or by unassisted, unsupervised persons whose physical, sensory or mental capabilities prevent them from using it safely. Children should be supervised to ensure that they do not play with the appliance.

Before starting up your machine, please check it carefully for any defects. If you find any, do not start up your machine. Contact your authorized Snow Joe® + Sun Joe® dealer or call the Snow Joe® + Sun Joe® customer service center at 1-866-SNOWJOE (1-866-766-9563).

**⚠️ WARNING!** When using the power cleaner, basic safety precautions should always be followed to reduce the risk of fire, electric shock, and personal injury. These include:

- **Know your product** – Know how to stop the machine quickly. Thoroughly familiarize yourself with the controls.
- **Keep bystanders away** – All visitors and pets should be kept a safe distance away from the work area.
- **Use the right product** – Do not use this machine for any job except that for which it is intended.
- **Dress properly** – Do not wear loose clothing or jewelry. They can get caught in moving parts. Protective rubber gloves and non-slip footwear are recommended when working outdoors.
- **⚠️ CAUTION!** – Exercise caution to avoid slipping or falling. Wear protective footwear that will protect your feet and improve your footing on slippery surfaces.

- **Stay alert** – Watch what you are doing. Use common sense. Do not operate the power cleaner when you are tired, or under the influence of alcohol or drugs.
- **Do not overreach** – Keep proper footing and balance at all times.
- **Avoid unintentional starting** – Do not carry a machine with power with your finger on the trigger. Make sure the switch is off before inserting the battery.
- **Remove the battery** – Remove the battery from the power cleaner when it is not in use, before servicing it, when changing accessories, and when performing any other maintenance task.
- **Use safety glasses** – Also use safety footwear, snug-fitting clothing, protective gloves, hearing and head protection.
- **Check the water temperature** – This power cleaner is not meant to pump hot water. **NEVER** connect it to a hot water supply as it will significantly reduce the life of the pump.
- **Store indoors** – **NEVER** store the power cleaner outdoors or where it could freeze. The pump could be seriously damaged.

**⚠️ WARNING!** Do not use this appliance without reading this instruction manual.

**⚠️ WARNING!** This appliance has been designed for use with cleaning agents that are recommended by the manufacturer. The use of other cleaning agents or chemicals may adversely affect the safety of the appliance.

**⚠️ WARNING!** Do not use the appliance within range of persons unless they are wearing protective clothing.

**⚠️ WARNING!** High-pressure jets can be dangerous if subject to misuse. The jet must not be directed at persons, pets, live electrical equipment, or the appliance itself.

- Do not direct the jet at yourself or others in order to clean clothes or footwear.
- **Risk of explosion** – Do not spray flammable liquids.
- **Keep children away** – This cordless power cleaner must not be used by children or untrained personnel. Close supervision is necessary when a product is used near children.
- To ensure appliance safety, use only original replacement parts from the manufacturer or those approved by the manufacturer.

**⚠️ WARNING!** During cleaning, maintenance or when replacing parts, the machine must be disconnected from its power source by removing the battery.

**⚠️ WARNING!** High-pressure hoses, fittings, and couplings are important for the safe operation of the appliance. Use only hoses, fittings, and couplings recommended by the manufacturer.

**⚠️ WARNING! Electrical Shock Hazard** – Before starting up your machine, please check it carefully for any defects. If you find any, do not start up your machine and contact your distributor.

**IMPORTANT:** Do not connect the machine to water supply which is turbid, muddy or corrosive. Not recommended for use with salt water, immediately rinse with fresh water for proper maintenance.

- **Check for damaged parts** – Do not use the appliance if any important parts of the appliance are damaged.
- This cordless power cleaner must not be used at temperatures below 32°F (0°C).
- In the event of an accident or breakdown, switch off the machine immediately. (If contact with detergent occurs, rinse with an abundance of clean water.)

## Electric Safety

**⚠️ WARNING!** Read all safety warnings and instructions. Failure to follow the warnings and instructions may result in electric shock, fire and/or serious injury.

1. Prevent unintentional starting. Ensure the switch is in the off-position before connecting with the battery pack, picking up or carrying the appliance. Carrying the appliance with your finger on the switch or energizing an appliance that has the switch on invites accidents.
2. Remove the battery pack from the appliance before making any adjustments, changing accessories, or storing appliance. Such preventive safety measures reduce the risk of starting the appliance accidentally.
3. Recharge only with the charger specified by the manufacturer. A charger that is suitable for one type of battery pack may create a risk of fire when used with another battery pack.
4. Use appliances only with specifically designated battery packs. Use of any other battery packs may create a risk of injury and fire.
5. When the battery pack is not in use, keep them away from other metal objects, like paper clips, coins, keys, nails, screws or other small metal objects, that can make a connection from one terminal to another. Shorting the battery terminals together may cause burns or a fire.
6. Under abusive conditions, liquid may be ejected from the battery; avoid contact. If contact accidentally occurs, flush with water. If liquid contacts eyes, additionally seek

medical help. Liquid ejected from the battery may cause irritation or burns.

7. Do not use a battery pack or appliance that is damaged or modified. Damaged or modified batteries may exhibit unpredictable behavior resulting in fire, explosion or risk of injury.
8. Do not expose a battery pack or appliance to fire or excessive temperature. Exposure to fire or temperature above 265°F (130°C) may cause explosion.
9. Follow all charging instructions and do not charge the battery pack or appliance outside of the temperature range specified in the instructions. Charging improperly or at temperatures outside of the specified range may damage the battery and increase the risk of fire.
10. Have servicing performed by a qualified repair person using only identical replacement parts. This will ensure that the safety of the product is maintained.
11. Do not modify or attempt to repair the appliance or the battery pack (as applicable) except as indicated in the instructions for use and care.

## Battery + Charger Safety Instructions

**NOTE:** This unit is tool only. The battery and the charger are not included. They must be purchased separately.

Model 24V-PP350-CT is compatible with the iON+ 24V System batteries and chargers. See page 14 for more information.

We pay a great deal of attention to the design of every battery pack to ensure that we supply you with batteries that are safe, durable and have a high energy density. The battery cells have a wide range of safety devices. Each individual cell is initially formatted and its electrical characteristic curves are recorded. This data is then used exclusively to be able to assemble the best possible battery packs.

Despite all the safety precautions, caution must always be exercised when handling the battery. The following points must be obeyed at all times to ensure safe use. Safe use can only be guaranteed if undamaged cells are used. Incorrect handling of the battery pack can cause cell damage.

**IMPORTANT!** Analyses confirm that incorrect use and poor care of high-performance batteries are the main factors responsible for personal and/or product damage.

**⚠️ WARNING!** Use only approved replacement batteries; other batteries may damage the cordless power cleaner and cause it to malfunction, which can lead to serious personal injury.

**⚠️ WARNING!** Do not use a battery pack or appliance that is damaged or modified. Damaged or modified battery may exhibit unpredictable behavior resulting in fire, explosion or risk of injury.

Do not modify or attempt to repair the appliance or the battery pack except as indicated in the instructions for use and care.

Have your battery pack serviced by a qualified repair person using only identical replacement parts. This will ensure that the safety of the battery pack is maintained.

**⚠ CAUTION!** To reduce the risk of injury, charge the 24V iON+ lithium-ion battery pack only in the designated 24V iON+ lithium-ion charger. Other types of chargers present risk of fire, personal injury and damage. Do not wire the battery pack to a power supply plug or car cigarette lighter. Such misuse will permanently disable or damage the battery pack.

- **Avoid dangerous environments** – Do not charge the battery pack in rain, snow or in damp or wet locations. Do not use the battery pack or charger in the presence of explosive atmospheres (gaseous fumes, dust or flammable materials) because sparks may be generated when connecting or disconnecting the battery pack, which could lead to a fire.
- **Charge in a well-ventilated area** – Do not block the charger vents. Keep them clear to allow for proper ventilation. Do not allow smoking or open flames near a charging battery pack. Vented gases may explode.

**NOTE:** The safe temperature range for the battery is 41°F – 105°F (5°C – 40.5°C). Do not charge the battery outside in freezing weather; charge it at room temperature.

- **Maintain charger cord** – When unplugging the charger, pull the plug, not the cord, from the receptacle to reduce the risk of damage to the electrical plug and cord. Never carry the charger by its cord or yank it by the cord to disconnect it from the receptacle. Keep the cord away from heat, oil and sharp edges. Make sure the cord will not be stepped on, tripped over or subjected to damage or stress when the charger is in use. Do not use the charger with a damaged cord or plug. Replace a damaged charger immediately.
- **Do not use an extension cord unless it is absolutely necessary** – Using the wrong, damaged or improperly wired extension cord poses a risk of fire and electric shock. If an extension cord must be used, plug the charger into a properly wired 16 gauge or larger extension cord with the female plug matching the male plug on the charger. Make sure that the extension cord is in good electrical condition.
- **Use only recommended attachments** – Use of an attachment not recommended or sold by the battery charger or battery pack manufacturer may result in risk of fire, electric shock or personal injury.
- **Unplug charger when not in use** – Make sure to disconnect battery pack from unplugged charger.

**⚠ WARNING!** To reduce the risk of electric shock, always unplug the charger before performing any cleaning or maintenance. Do not allow water to flow into the charger. Use a Ground Fault Circuit Interrupter (GFCI) to reduce shock hazards.

- **Do not burn or incinerate battery pack** – Battery pack may explode, causing personal injury or damage. Toxic fumes and materials are created when the battery pack is burned.
- **Do not crush, drop or damage battery pack** – Do not use the battery pack or charger if they have sustained a sharp blow, been dropped, run over or have been damaged in any way (i.e. pierced with a nail, hit with a hammer, stepped on, etc.).
- **Do not disassemble** – Incorrect reassembly may pose a serious risk of electric shock, fire or exposure to toxic battery chemicals. If the battery or charger are damaged, contact an authorized Snow Joe® + Sun Joe® dealer or call the Snow Joe® + Sun Joe® customer service center at 1-866-SNOWJOE (1-866-766-9563) for assistance.
- **Battery chemicals cause serious burns** – Never let a damaged battery pack contact the skin, eyes or mouth. If a damaged battery pack leaks battery chemicals, use rubber or neoprene gloves to safely dispose of it. If skin is exposed to battery fluids, wash the affected area with soap and water and rinse with vinegar. If eyes are exposed to battery chemicals, immediately flush with water for 20 minutes and seek medical attention. Remove and dispose of contaminated clothing.
- **Do not short circuit** – A battery pack will short circuit if a metal object makes a connection between the positive and negative contacts on the battery pack. Do not place a battery pack near anything that may cause a short circuit, such as paper clips, coins, keys, screws, nails and other metallic objects. A short-circuited battery pack poses a risk of fire and severe personal injury.
- **Store your battery pack and charger in a cool, dry place** – Do not store the battery pack or charger where temperatures may exceed 105°F (40.5°C), such as in direct sunlight or inside a vehicle or metal building during the summer.

## Information about the battery

1. For optimum battery performance, avoid low discharge cycles by charging the battery pack frequently.
2. Store the battery pack in a cool place, ideally at 77°F (25°C) and charged to at least 40%.
3. Lithium-ion batteries are subject to a natural aging process. The battery pack must be replaced at the latest when their capacity falls to just 80% of its capacity when new. Weakened cells in an aged battery pack are no longer capable of meeting the high power requirements needed for the proper operation of your power cleaner, and therefore pose a safety risk.
4. Do not throw the battery pack into an open fire as this poses a risk of explosion.
5. Do not ignite the battery pack or expose it to fire.
6. Do not exhaustively discharge the battery. Exhaustive discharge will damage the battery cells. The most common cause of exhaustive discharge is lengthy storage or non-use of partially discharged battery. Stop working as soon as the performance of the battery fall noticeably or

the electronic protection system triggers. Place the battery pack in storage only after it has been fully charged.

7. Protect the battery and the tool from overloads. Overloads will quickly result in overheating and cell damage inside the battery housing even if this overheating is not apparent externally.
8. Avoid damage and shocks. Immediately replace the battery that has been dropped from a height of more than one meter or has been exposed to violent shocks, even if the housing of the battery pack appears to be undamaged. The battery cells inside the battery may have suffered serious damage. In such instances, please read the waste disposal information for proper battery disposal.
9. If the battery pack suffers overloading and overheating, the integrated protective cutoff will switch off the equipment for safety reasons.  
**IMPORTANT!** Do not press the ON/OFF switch any more if the protective cut-off has been activated. This may damage the battery pack.
10. Use only original battery pack. The use of other batteries poses a fire risk and may result in injuries or an explosion.

## Information about the charger and the charging process











1. Please check the data marked on the rating plate of the battery charger. Be sure to connect the battery charger to a power supply with the voltage marked on the rating plate. Never connect it to a different mains voltage.
2. Protect the battery charger and its cord from damage. Keep the charger and its cord away from heat, oil and sharp edges. Have damaged cords repaired without delay by a qualified technician at an authorized Snow Joe® + Sun Joe® dealer or call the Snow Joe® + Sun Joe® customer service center at 1-866-SNOWJOE (1-866-766-9563).
3. Electrical plugs must match the outlet. Never modify the plug in any way. Do not use any adapter plugs with grounded appliances. Unmodified plugs and matching outlets will reduce the risk of electric shock.
4. Keep the battery charger, battery pack and the cordless tool out of the reach of children.
5. Do not use the supplied battery charger to charge other cordless tools.
6. During periods of heavy use, the battery pack will become warm. Allow the battery pack to cool to room temperature before recharging.
7. Do not overcharge the battery. Do not exceed the maximum charging times. These charging times only apply to discharged batteries. Frequent connection of a charged or partially charged battery pack will result in overcharging and cell damage. Do not leave the battery connected with the charger for days on end.
8. Never use or charge battery if you suspect that it has been more than 12 months since the last time they were charged. There is a high probability that the battery pack has already suffered dangerous damage (exhaustive discharge).
9. Charging the battery at a temperature below 41°F (5°C) will cause chemical damage to the cells and may cause a fire.
10. Do not use batteries that have been exposed to heat during the charging process, as the battery cells may have suffered dangerous damage.
11. Do not use the battery if it suffered curvature or deformation during the charging process or exhibit other atypical symptoms (gassing, hissing, cracking, etc.).
12. Never fully discharge the battery pack (maximum recommended depth of discharge is 80%). A complete discharge of the battery pack will lead to premature aging of the battery cells.

## Protection from environmental influences

1. Wear suitable work clothes. Wear safety goggles.
2. Protect your cordless tool and the battery charger from moisture and rain – Moisture and rain can cause dangerous cell damage.
3. Do not use the cordless tool or the battery charger near vapors and flammable liquids.
4. Use the battery charger and cordless tools only in dry conditions and at an ambient temperature of 41°F – 105°F (5°C – 40.5°C).
5. Do not keep the battery charger in places where the temperature is liable to reach over 105°F (40.5°C). In particular, do not leave the battery charger in a car that is parked in the sunshine.
6. Protect batteries from overheating. Overloads, overcharging and exposure to direct sunlight will result in overheating and cell damage. Never charge or work with batteries that have been overheated – replace them immediately, if possible.
7. Store the charger and your cordless tool only in dry locations with an ambient temperature of 41°F – 105°F (5°C – 40.5°C). Store your lithium-ion battery packs in a cool, dry place at a temperature of 77°F (25°C). Protect the battery pack, charger and cordless tool from humidity and direct sunlight. Only place fully charged batteries in storage (charged to at least 40%).
8. Prevent the lithium-ion battery pack from freezing. Battery packs that were stored below 32°F (0°C) for more than 60 minutes must be discarded.
9. When handling the battery, be wary of electrostatic charge. Electrostatic discharges can damage the electronic protection system and the battery cells. Avoid electrostatic charging and never touch the battery poles.

# Safety Symbols

The following table depicts and describes safety symbols that may appear on this product. Read, understand, and follow all instructions on the machine before attempting to assemble and operate.

Symbols	Descriptions	Symbols	Descriptions
	<b>READ THE OPERATOR'S MANUAL(S)</b> – Read, understand, and follow all instructions in the user manual(s) before attempting to assemble and operate.		<b>SAFETY ALERT</b> – Indicates a precaution, a warning, or a danger.
	<b>WARNING!</b> Do not expose the unit to rain or wet conditions. Keep dry.		<b>WEAR EYE AND HEARING PROTECTION</b> – For protection against injury, wear ear defenders and safety goggles.
	To reduce the risk of injury, user must keep all bystanders at least 49 ft (15 m) away.		Machine not suitable for connection to the potable water mains.
	Wear safety gloves during use to protect hands.		Wear non-slip footwear that will protect your feet and improve your footing on slippery surfaces.
	Store indoors. Never store the power cleaner outdoors. If the pump freezes, permanent damage may result.		Indoor use only. Only use battery charger indoors.

# Know Your Cordless Portable Power Cleaner

Read the owner's manual and safety instructions carefully before operating the cordless portable power cleaner. Compare the illustration below to the cordless portable power cleaner in order to familiarize yourself with the location of the various controls and adjustments. Save this manual for future reference.

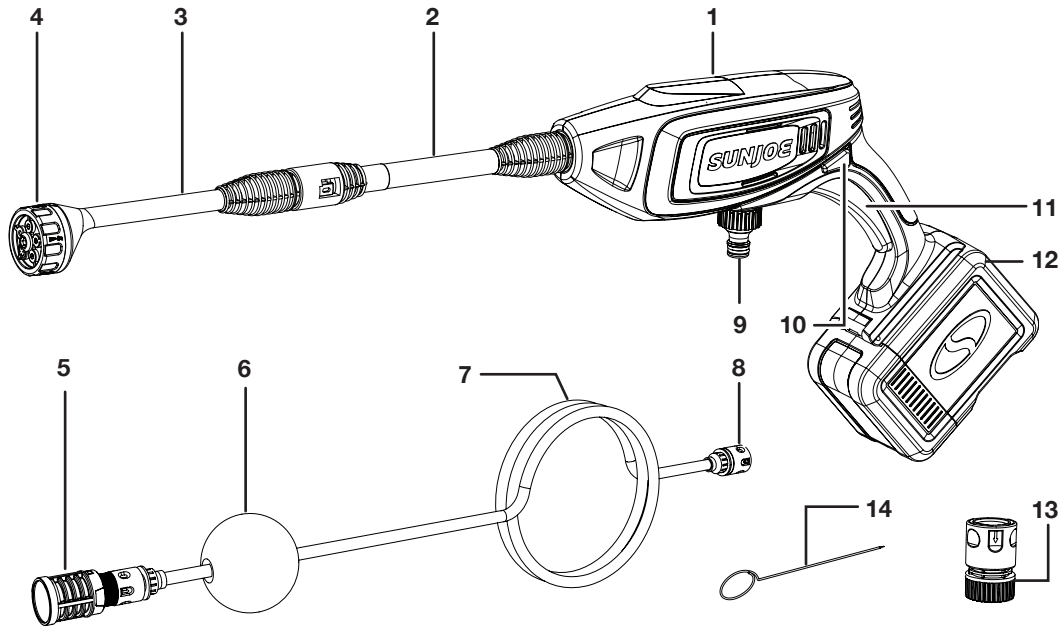

- |                           |                           |
|---------------------------|---------------------------|
| 1. Cordless power cleaner | 8. Quick connector        |
| 2. Extension wand         | 9. Siphon hose adapter    |
| 3. Spray wand             | 10. Safety lock button    |
| 4. Multi-spray nozzle     | 11. On/Off trigger        |
| 5. Hose filter            | 12. Battery compartment   |
| 6. Floater                | 13. Garden hose adapter   |
| 7. Siphon hose            | 14. Needle clean-out tool |

**SOLD SEPARATELY**

Battery + Charger options available at [sunjoe.com](http://sunjoe.com)

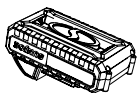

24VBAT-LTE

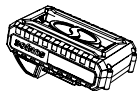

24VBAT-LT



24VBAT



24VBAT-XR



24VCHRG-QC

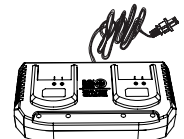

24VCHRG-DPC

## Technical Data

Battery Voltage	24 V D.C.
Battery Capacity	See page 14 for battery options and specifications
Battery Run Time Max	See page 14 for battery options and specifications
Charger Input	See page 14 for battery options and specifications
Charger Output	See page 14 for battery options and specifications
Charge Time Max	See page 14 for battery options and specifications
Motor	180 W brush
Max Water Inlet Temperature	104°F/40°C
Siphon Hose Length	20 ft (6 m)
Max Water Inlet Pressure	0.6 MPa
Max Flow <sup>†</sup>	0.6 GPM
Rated Flow	0.55 GPM
Max Pressure <sup>†</sup>	350 PSI
Rated Pressure	320 PSI (connecting with spigot) 275 PSI (connecting with fresh/bucket water)
Nozzle Patterns	5
Extension Wand Length	11.9 inch (30.2 cm)
Nozzle Wand Length	11.6 inch (29.5 cm)
Weight (unit only)	5.5 lbs (2.5 kg)

\* Initial no-load voltage, when fully charged, peaks at 24 volts; nominal voltage under typical load is 21.6 volts.

<sup>†</sup> Max rating per CSA test standards. Maximum internal pressure is 350 PSI and flow is 0.6 GPM. Under typical load, working pressure is 320 PSI and flow is 0.55 GPM.

## Unpacking

### Carton Contents

- Cordless power cleaner
- Extension wand
- Spray wand
- Siphon hose
- Garden hose adapter
- Needle clean-out tool
- Manuals with registration card

**NOTE:** In order to operate this cordless power cleaner you will need iON+ 24V System battery and chargers. See page 14 for battery options and specifications, or visit [sunjoe.com](http://sunjoe.com).

1. Carefully remove the power cleaner and check to see that all of the above items are supplied.
2. Inspect the product carefully to make sure no breakage or damage occurred during shipping. If you find damaged or missing parts, DO NOT return the unit to the store. Please call the Snow Joe® + Sun Joe® customer service center at 1-866-SNOWJOE (1-866-766-9563).

**NOTE:** Do not discard the shipping carton and packaging material until you are ready to use your new cordless power cleaner. The packaging is made of recyclable materials. Properly dispose of these materials in accordance with local regulations.

**IMPORTANT!** The equipment and packaging material are not toys. Do not let children play with plastic bags, foils, or small parts. These items can be swallowed and pose a suffocation risk!

**⚠ WARNING!** Do not insert the battery until assembly is complete. Failure to comply could result in accidental starting and possible serious personal injury.

## Battery Pack Operation

The equipment is powered by a lithium-ion battery. The battery pack is completely sealed and maintenance free.

## TOOL ONLY





### BATTERY + CHARGER SOLD SEPARATELY

In order to operate this cordless power cleaner you will need and a iON+ 24V System battery and charger. See page 14 for battery and charger options and specifications, or for more information visit [sunjoe.com](http://sunjoe.com).

## Battery Charge Level Indicator

The battery pack is equipped with a push button for checking the charge level. Simply press the push button to read off the battery charge level from the LEDs of the battery indicator:

- All 3 level monitoring LEDs are lit: Battery charge level is high.
- 2 level monitoring LEDs are lit: Battery charge level is decreasing. Stop work as soon as possible.
- 1 level monitoring LED is lit: Battery is flat. Stop work IMMEDIATELY and charge the battery. Otherwise the battery's service life will be greatly shortened.

Lights	Light Indicators
	Charge level button
	The battery is at 30% capacity and requires charging
	The battery is at 60% capacity and requires charging soon
	The battery is at full capacity

**NOTE:** If the charge level button does not appear to be working, connect to the charger and charge as needed.

**NOTE:** Immediately after using the battery pack, the charge level button may display a lower charge than it will if checked a few minutes later. The battery cells "recover" some of their charge after resting.

## Charger Operation

### TOOL ONLY

#### BATTERY + CHARGER SOLD SEPARATELY

In order to operate this cordless power cleaner you will need and a iON+ 24V System battery and charger. See page 14 for battery and charger options and specifications, or for more information visit [sunjoe.com](http://sunjoe.com).

**⚠ WARNING!** Charge only 24V iON+ lithium-ion battery pack with its compatible 24V iON+ lithium-ion charger. Other types of batteries may cause personal injury and damage.

To reduce the risk of electric shock, do not allow water to flow into the charger's AC/DC plug.

### When to Charge the iON+ 24V Lithium-iON Battery

**NOTE:** The iON+ 24V lithium-ion battery packs do not develop a "memory" when charged after only a partial discharge. Therefore, it is not necessary to run down the battery packs before placing them into the charger.

- Use the battery charge indicator lights to determine when to charge your iON+ 24V lithium-ion battery packs.
- You can "top-off" your battery packs' charge before starting a big job or after a long day of use.

## Charging the Battery

1. Open the battery compartment cover, and push the push lock buttons on the battery to pull the battery pack out from the battery compartment (Fig. 1).

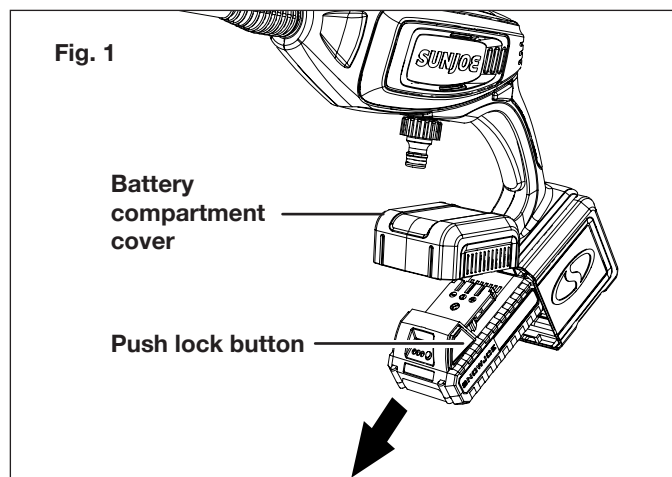

2. Depending on your Snow Joe® + Sun Joe® charger model, how to recharge your lithium-ion batteries will vary. You may either insert your 24-volt batteries into the 24VCHRG-QC Quick Charger (sold separately) or the 24VCHRG-DPC Dual Port Charger (sold separately) (Figs. 2 – 3).

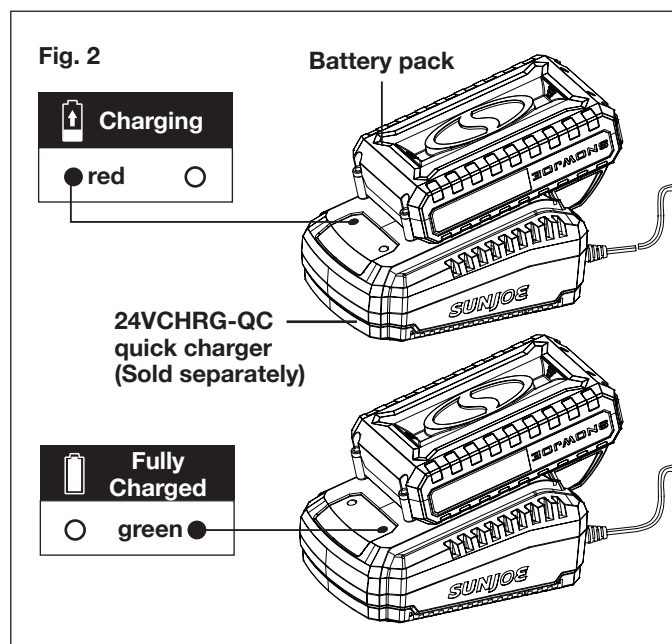



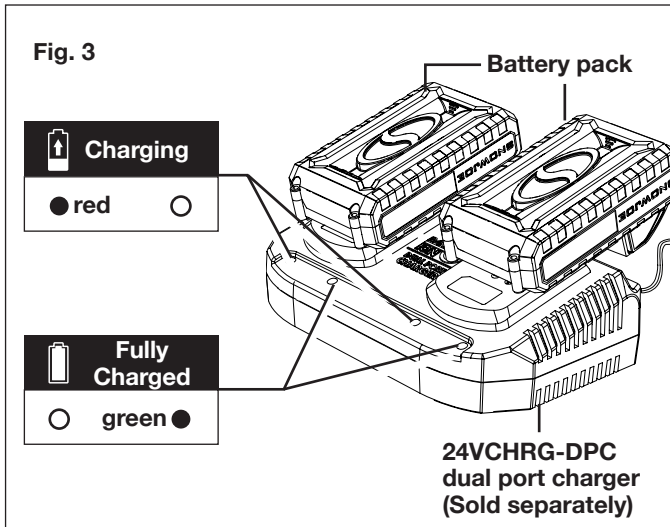

- The battery indicator LEDs will illuminate one by one during the charging process. Unplug the charger immediately when the 3 LEDs are all illuminated.
- The 24VCHRG-QC Quick Charger (sold separately) and the 24VCHRG-DPC Dual Port Charger (sold separately) are also equipped with additional charging indicating lights which will indicate the charging status (Figs. 2 – 3).

**CAUTION!** FIRE HAZARD. When disconnecting the charger from the battery, be sure to unplug the charger from the outlet first, then disconnect the charger from the battery.

**WARNING!** The chargers do not automatically turn off when the battery is fully charged. Please take care not to leave the battery plugged into the charger. Switch off or unplug the charger at the mains when charging is complete.

- Timely recharging of the battery will help prolong the battery's life. You must recharge the battery pack when you notice a drop in the equipment's power.

**IMPORTANT!** Never allow the battery pack to become fully discharged as this will cause irreversible damage to the battery.

- When charging is complete, remove the battery from the charger by pulling the push lock button and sliding the battery backward to unlock it from the charger.

## Assembly

**WARNING!** To avoid serious personal injury, read and understand all safety instructions provided.

**WARNING!** Do not insert battery until assembly is complete. Failure to comply could result in accidental starting and possible serious personal injury.

**WARNING!** Before performing any maintenance, make sure battery is removed. Failure to heed this warning could result in serious personal injury.

**WARNING!** To prevent serious personal injury, make sure the unit is powered off, and the battery is removed before attaching or detaching the wands.

## Wands Assembly

**NOTE:** The portable power cleaner is equipped with two wands: the spray wand and the extension wand. To connect the wands, follow the instruction below.

- First, fit the extension wand into the gun firmly by aligning the two tabs on the wand with the grooves in the gun, and rotate it clockwise until the two parts are completely locked (Fig. 4).

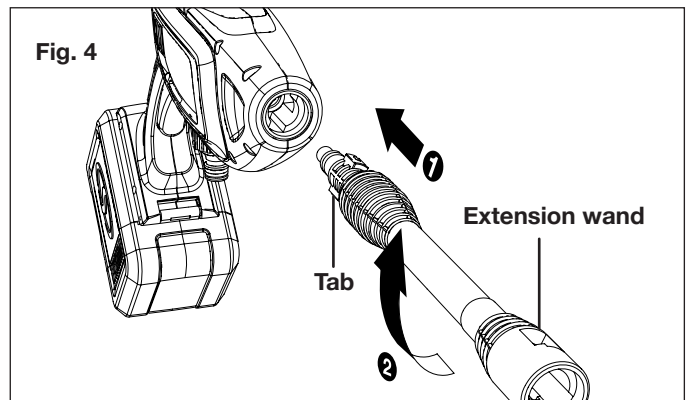

- Attach the spray wand into the extension wand by the same method (Fig. 5).

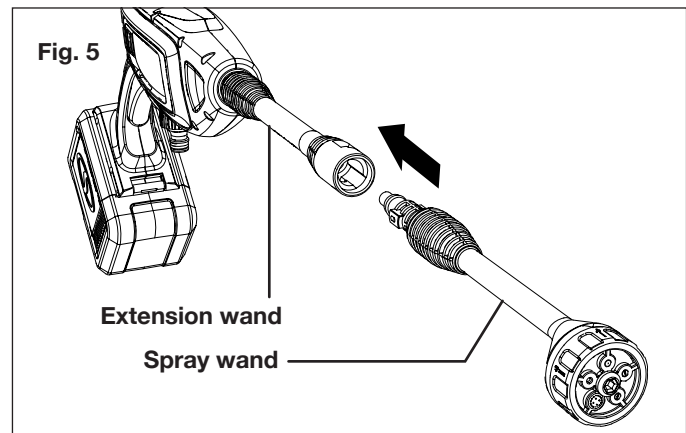

## Connect to Water Source

The power cleaner can be connected with spigot by a regular garden hose with the included garden hose adapter, and can be connected with fresh water or bucket water with the included siphon hose.

**CAUTION!** The power cleaner must only be used with clean (fresh) water; use of unfiltered water containing corrosive chemicals will damage the power cleaner.

**WARNING!** When connecting with fresh water (lake, spring, pond) make sure to use the equipped siphon hose. The siphon hose has a filter on the end, which will filter out dirt from fresh water sources.

**⚠️ WARNING!** The intake water temperature must not exceed 104°F/40°C.

#### To connect with fresh water/bucket water

1. To connect the equipped siphon hose with the power cleaner, pull down the collar of the quick connector and fit it onto the adapter. Release the collar to lock the hose in place (Fig. 6).

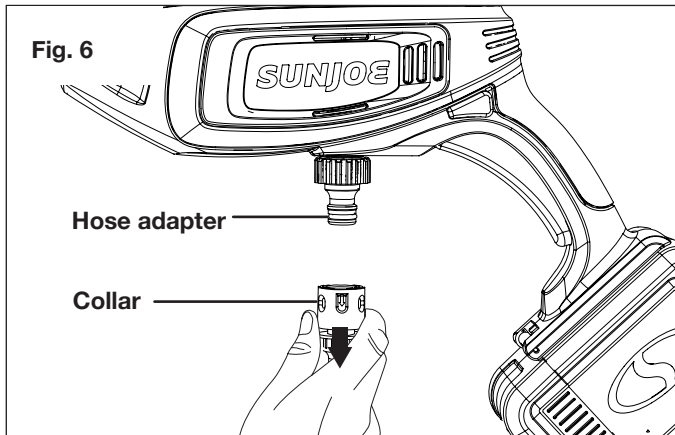

**NOTE:** Make sure the hose is connected securely. Gently pull the hose connection to confirm it won't come off.

2. Drop the other end with the filter into a bucket of water or into fresh water. Adjust the floater's position up or down as needed to ensure the filter remains submerged below the surface of the water.

#### To connect with spigot

1. First, connect the power cleaner with the provided garden hose adapter. Pull down the collar of the garden hose adapter and fit it onto the siphon hose adapter. Release the collar to lock the adapter in place. Then connect the garden hose to the garden hose adapter. Twist tightly to secure (Fig. 7).

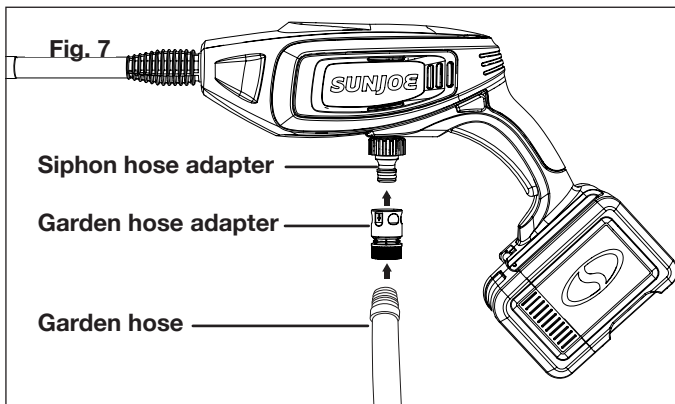

2. Attach the other end of the garden hose to water supply (Fig. 8).

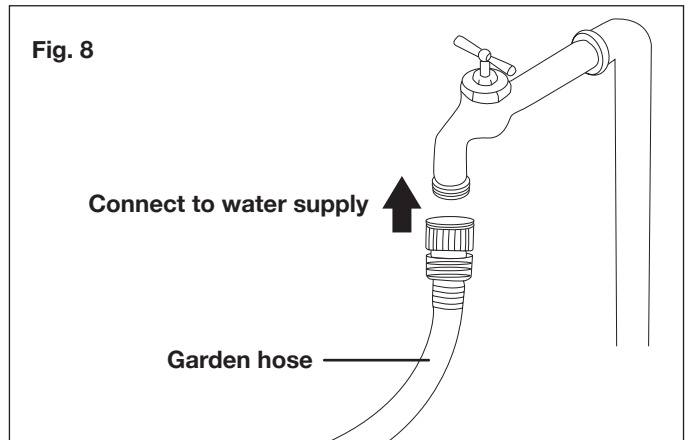

**⚠️ WARNING!** Keep hose away from sharp objects. Bursting hoses may cause injury. Examine hoses regularly and replace if damaged. Do not attempt to mend a damaged hose.

**⚠️ WARNING!** Water that has flowed through back flow preventers is considered to be non-potable.

## Operation

### Starting the Cleaner

**TOOL ONLY**  
**BATTERY + CHARGER SOLD SEPARATELY**

In order to operate this cordless power cleaner you will need and a iON+ 24V System battery and charger. See page 14 for battery and charger options and specifications, or for more information visit [sunjoe.com](http://sunjoe.com).

1. Make sure the power cleaner is connected with proper water source. Slide the battery in the battery compartment until it clicks to lock it into position. Close the battery compartment cover (Fig. 9).

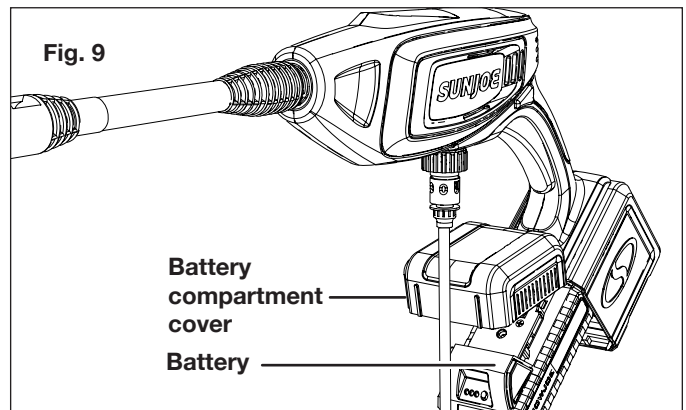

2. If connected with a spigot, turn the water supply tap on completely.

3. Push the safety lock on the spray gun handle, with the safety lock pressed, engage the trigger for a few seconds until the water flow is steady (Fig. 10).

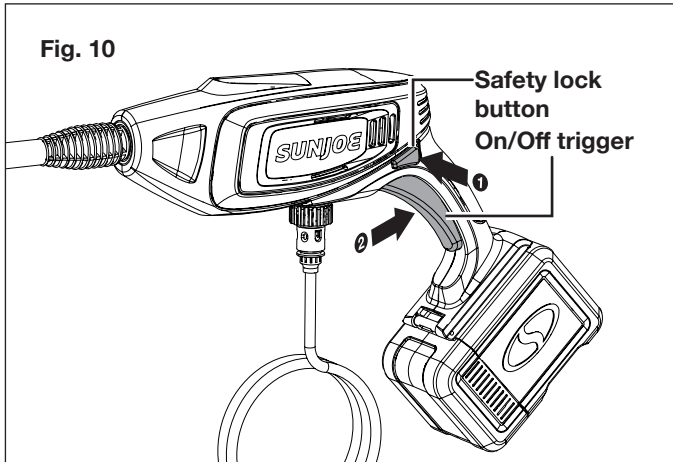

## Using the Multi-spray Nozzle

Before beginning any cleaning task, determine the best spray setting for the job. The multi-spray nozzle has 5 different spray patterns: shower pattern (for plant watering), 40° (for gentle cleaning), 25° (for all-purpose cleaning), 0+ (for tough jobs), and 0° (for spot cleaning or hard-to-reach areas) .

**CAUTION!** NEVER change spray pattern without stopping the power cleaner and the battery removed.

**WARNING!** High-pressure jets can be dangerous if subject to misuse. The jet must not be directed at persons, pets, live electrical equipment, or the appliance itself.

To change the spray pattern:

1. Turn off the power cleaner, remove the battery.
2. Select the right spray pattern for the job (Fig. 11).

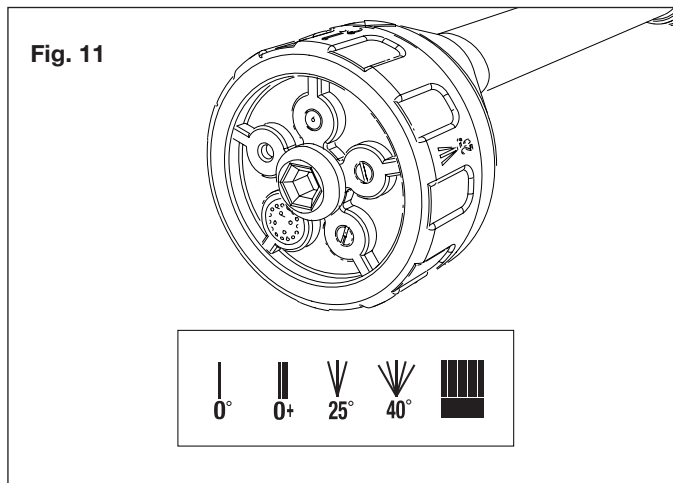

- I) The 0° intense-jet spray pattern is an extremely powerful nozzle that delivers a high-pressure, pencil-point jet stream. It is used to cut heavy dirt deposits in a small, concentrated area. It is ideal for dissolving stubborn substances, like tar and grease spots on concrete, or for removing caked mud from equipment. Use this pattern to clean hard-to-reach areas including the facades of 2-story buildings or the undersides of lawn mowers and tractors.

**NOTE:** Care should be used when choosing the right spray pattern to avoid permanently gouging wood or damaging fragile surfaces.

- II) Use the 0+ spray pattern for intense cleaning jobs on hard surfaces. Applications include stripping paint, removing oil stains, grease, heavy mildew stains, and rust from steel. This pattern should only be used in areas that can withstand the high-pressure from this pattern.
- III) Use the 25° fan-tip spray pattern to clean home siding, brick patios, wood decks, driveways, or sidewalks. When using this spray pattern, test a small area first to avoid surface damage.
- IV) Use the 40° wide-spray spray pattern to clean items such as cars, trucks, boats, patio furniture, or lawn equipment.
- V) Use the showering spray pattern for some light cleaning and watering plants.

3. Twist the nozzle collar to align the symbol of the desired spray pattern with the mark on the nozzle (Fig. 12).

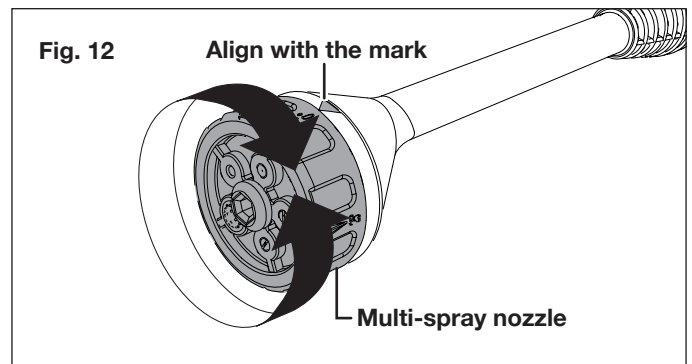

4. Insert the battery and start the machine. Start at the top of the area to be rinsed and work your way down, making sure to overlap your strokes.

## Shutting Down

1. Release the trigger. Remove the battery.
2. Remove the siphon hose out from the bucket/fresh water or turn off the water source.
3. Disconnect the siphon/garden hose connection on the power cleaner.

## Storage

**⚠ CAUTION!** Always store your power cleaner in a location where the temperature will not fall below 32°F (0°C). The pump in this machine is susceptible to permanent damage if it freezes. **FREEZE DAMAGE IS NOT COVERED BY THE WARRANTY.**

- Store the power cleaner indoors in a dry, covered area where it is not subject to adverse weather conditions.
- It is important to store this product in a frost-free area.
- Always empty water from all hoses, attachments and pump, before storing.

## Maintenance

**⚠ CAUTION!** Before working on the power cleaner, remove the battery from the compartment.

1. To ensure good performance, check and clean the water inlet filter on the end of the siphon hose. Remove and disassemble the filter and rinse all components with warm water to prevent any foreign matter from clogging the pump (Figs. 13 – 14).

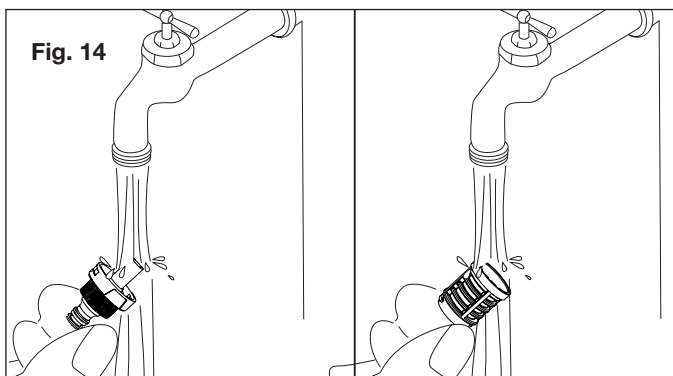
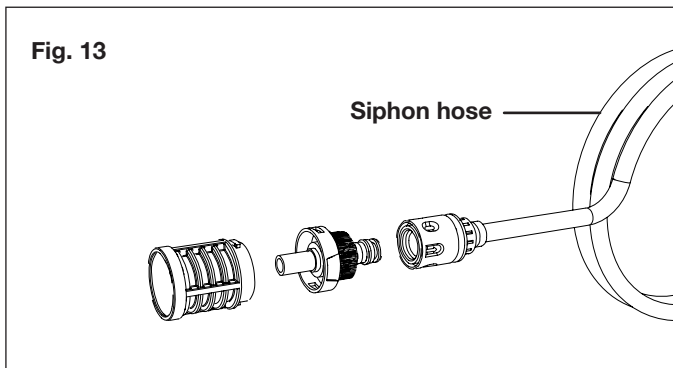

2. Clean the nozzle with the needle clean-out tool provided (Fig. 15). Remove the spray wand from the gun; remove any dirt from the nozzle hole and rinse.

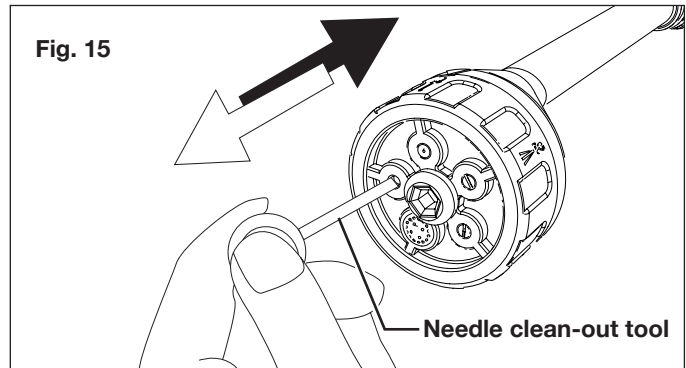

## Disposal

### Recycling the Cleaner

- Do not dispose of appliances as unsorted municipal waste. Use separate collection facilities.
- Contact your local government agency for information regarding the collection systems available.
- If appliances are disposed of in landfills or dumps, hazardous substances can leak into the groundwater and get into the food chain, damaging your health and well-being.
- When replacing old appliances with new ones, the retailer is legally obligated to take back your old appliance for disposal at least free of charge.

### Recycling + Disposal

The product comes in a package that protects it against damage during shipping. Keep the package until you are sure that all parts have been delivered and the product is functioning properly. Recycle the package afterwards or keep it for long-term storage.

### Battery Caution + Disposal

Always dispose of your battery pack according to federal, state, and local regulations. Contact a recycling agency in your area for recycling locations.

**⚠ CAUTION!** Even discharged battery packs contain some energy. Before disposing, use electrical tape to cover the terminals to prevent the battery pack from shorting, which could cause a fire or explosion.

**⚠ WARNING!** To reduce the risk of injury or explosion, never burn or incinerate a battery pack even if it is damaged, dead or completely discharged. When burned, toxic fumes and materials are emitted into the surrounding atmosphere.

1. Batteries vary according to device. Consult your manual for specific information.
2. Install only new batteries of the same type in your product (where applicable).
3. Failure to insert batteries in the correct polarity, as indicated in the battery compartment or manual, may shorten the life of the batteries or cause batteries to leak.
4. Do not mix old and new batteries.
5. Do not mix Alkaline, Standard (Carbon-Zinc) or Rechargeable (Nickel Cadmium, Nickel Metal Hydride, or Lithium-Ion) batteries.
6. Do not dispose of batteries in fire.
7. Batteries should be recycled or disposed of as per state and local guidelines.

## Service + Support

If your Sun Joe® 24V-PP350-CT cordless portable power cleaner requires service or maintenance, please call the Snow Joe® + Sun Joe® customer service center at 1-866-SNOWJOE (1-866-766-9563).

## Model + Serial Numbers

When contacting the company, reordering parts, or arranging service from an authorized dealer, you will need to provide the model and serial numbers, which can be found on the decal located on the housing of the unit. Copy these numbers into the space provided below.

Record the following numbers from the housing or handle of your new product:

Model #:



2	4	V	-	P	P	3	5	0	-	C	T								
---	---	---	---	---	---	---	---	---	---	---	---	--	--	--	--	--	--	--	--



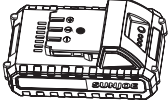
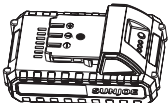
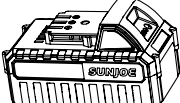

Serial #:

--	--	--	--	--	--	--	--	--	--	--	--	--	--	--	--	--	--	--	--	--

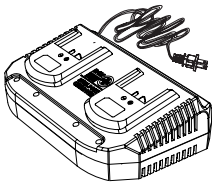
# Optional Accessories

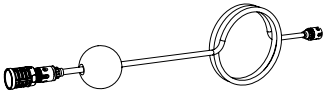
**⚠️ WARNING!** ALWAYS use only authorized Snow Joe® + Sun Joe® replacement parts and accessories. NEVER use replacement parts or accessories that are not intended for use with this cordless power cleaner. Contact Snow Joe® + Sun Joe® if you are unsure whether it is safe to use a particular replacement part or accessory with your power cleaner. The use of any other attachment or accessory can be dangerous and could cause injury or mechanical damage.

Accessories	Item	Model
	24V iON+ 2.0 Ah Lithium-Ion Battery <i>Battery Charge Time Max:</i> 24VCHRG-QC: 55 min   24VCHRG-DPC: 55 min <i>Battery Runtime Max: 12 min</i>	24VBAT-LTE
	24V iON+ 2.5 Ah Lithium-Ion Battery <i>Battery Charge Time Max:</i> 24VCHRG-QC: 1 hr 10 min   24VCHRG-DPC: 1 hr 10 min <i>Battery Runtime Max: 15 min</i>	24VBAT-LT
	24V iON+ 4.0 Ah Lithium-Ion Battery <i>Battery Charge Time Max:</i> 24VCHRG-QC: 1 hr 50 min   24VCHRG-DPC: 1 hr 50 min <i>Battery Runtime Max: 24 min</i>	24VBAT
	24V iON+ 5.0 Ah Lithium-Ion Battery <i>Battery Charge Time Max:</i> 24VCHRG-QC: 2 hr 20 min   24VCHRG-DPC: 2 hr 20 min <i>Battery Runtime Max: 30 min</i>	24VBAT-XR
	24V iON+ Lithium-Ion Battery Quick Charger	24VCHRG-QC
	24V iON+ Lithium-Ion Dual-Port Battery Charger	24VCHRG-DPC

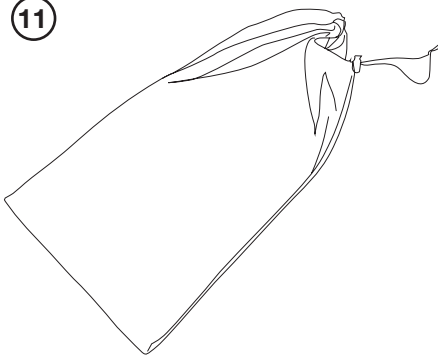
Accessories	Item	Model
	Sun Joe® Replacement Siphon Hose	24V-PP350-WH
	Sun Joe® Utility Brush Attachment	24V-PP350-UB
	Sun Joe® Garden Hose Attachment	24V-PP350-HA
	Sun Joe® Detergent Attachment	24V-PP350-DB
	Storage Bag	24V-PP350-BAG

**NOTE:** Accessories are subject to change without any obligation on the part of Snow Joe® + Sun Joe® to provide notice of such changes. Accessories can be ordered online at [sunjoe.com](http://sunjoe.com) or via phone by contacting the Snow Joe® + Sun Joe® customer service center at 1-866-SNOWJOE (1-866-766-9563).





**NOTES**

---

---

---

---

---

---

---

---

---

---

---

---

---

---

---

---

---

---

---

---

---

---

---

---

---

**NOTES**

---

---

---

---

---

---

---

---

---

---

---

---

---

---

---

---

---

---

---

---

---

---

---



## SNOW JOE® + SUN JOE® CUSTOMER PROMISE

**ABOVE ALL ELSE**, Snow Joe® + Sun Joe® are dedicated to you, our customer. We strive to make your experience as pleasant as possible. Unfortunately, there are times when a product does not work or breaks under normal operating conditions. We think it's important that you know what you can expect from us. That's why we created the Snow Joe® + Sun Joe® promise.

**OUR PROMISE:** Snow Joe® + Sun Joe® warrant new products for two years from the date of purchase. If your product does not work, or there's an issue with a specific part, we will fix this by either sending you a free replacement part or by sending you a new or comparable product at no charge. How cool is that! Before you know it, you'll be back in action cutting, sawing, mowing, washing and...?

### PRODUCT REGISTRATION:

Snow Joe®, LLC ("Snow Joe® + Sun Joe®") strongly encourages you to register your purchase. You can register online at [snowjoe.com/register](http://snowjoe.com/register), or by printing and mailing in a registration card available online from our website, or calling our Customer Service Department at **1-866-SNOWJOE (1-866-766-9563)**, or by e-mailing us at [help@snowjoe.com](mailto:help@snowjoe.com). Failure to register your product purchase will not diminish your warranty rights. However, registering your purchase will allow Snow Joe® + Sun Joe® to better serve you with any of your customer service needs.

### WHO CAN SEEK WARRANTY COVERAGE?

This Warranty is extended by Snow Joe® + Sun Joe® to the owner of this Machine (a "Machine" consists of a product powered by a motor) for residential and personal household use only. This Warranty does not apply to products used for commercial, rental or re-sale purposes. Should ownership of this machine change during the 2-year period, please update the Machine's owner information at [snowjoe.com/register](http://snowjoe.com/register).

### WHAT IS COVERED?

Snow Joe® + Sun Joe® warrants to the owner that if this Machine fails within 2 years from the date of purchase due to a defect in material or workmanship or as a result of normal wear and tear from ordinary household use, Snow Joe® + Sun Joe® will send a replacement part or product, as needed, free of charge and with free shipping to the original purchaser.

If, in Snow Joe® + Sun Joe®'s sole discretion, the failed Machine cannot be repaired with a part, Snow Joe® + Sun Joe® will elect to either (A) send a new Machine at no charge and with free shipping or (B) refund the full purchase price to the owner.

### WHAT IS NOT COVERED?

This Warranty does not apply to the Machines that have been used commercially or in non-household applications. This Warranty does not cover cosmetic changes that do not affect performance. This Warranty is only valid if the Machine is used and maintained in accordance with the instructions, warnings and safeguards contained in the owner's manual. Snow Joe® + Sun Joe® will not be responsible for the cost of any unauthorized warranty repairs. This warranty does not cover any cost or expense incurred by the purchaser in providing substitute equipment or service during reasonable periods of malfunction or non-use of this product while waiting for a replacement part or unit under this warranty.

Wearing parts like belts, augers, chains and tines are not covered under this warranty, and can be purchased at [snowjoe.com](http://snowjoe.com) or by calling **1-866-SNOWJOE (1-866-766-9563)**. Batteries are covered in full for 2 years from the date of purchase.

Repair, replacement or refund of the purchase price are the exclusive remedies of purchaser and the sole liability of Snow Joe® + Sun Joe® under this warranty. No employee or representative of Snow Joe® + Sun Joe® is authorized to make any additional warranty or any modification to this warranty which may be binding upon Snow Joe® + Sun Joe®. Accordingly, purchaser should not rely upon any additional statements made by any employee or representative of Snow Joe® + Sun Joe®. In no event, whether based on contract, indemnity, warranty, tort (including negligence), strict liability or otherwise, shall Snow Joe® + Sun Joe® be liable for any special, indirect, incidental, or consequential damages, including, without limitation, loss of profit or revenue.

Some states do not allow limits on warranties. In such states, the above limitations may not apply to you.

Outside the USA, other warranties may apply.



**[sunjoe.com](http://sunjoe.com)**